

**amaran**<sup>®</sup>  
by Aputure<sup>®</sup>



# amaran T4c

Product Manual

English

## Foreword

Thank you for purchasing "amaran" LED photography lights - amaran T4c. Amaran T4c is amaran newly designed cost performance light fixture. Compact structure design, compact and light , excellent texture. Has a high performance level, such as high brightness, high color rendering index, can adjust the brightness, etc. It can be used with variety of lighting accessories to achieve lighting effects and enrich product usage patterns. So that the product to meet the needs of different occasions light control, easy to achieve professional level photography.

## IMPORTANT SAFETY INSTRUCTIONS

When using this unit, basic safety precautions should always be followed, including the following:

1. Read and understand all instructions before using.
2. Close supervision is necessary when any fixture is used by or near children. Do not leave the fixture unattended while in use.
3. Care must be taken as burns can occur from touching hot surfaces.
4. Do not operate the fixture if a cord is damaged, or if the fixture has been dropped or damaged, until it has been examined by qualified service personnel.
5. Position any power cables such that they will not be tripped over, pulled, or put into contact with hot surfaces.
6. If an extension cord is necessary, a cord with an amperage rating at least equal to that of the fixture should be used. Cords rated for less amperage than the fixture may overheat.
7. Always unplug the lighting fixture from the electrical outlet before cleaning and servicing, or when not in use. Never yank the cord to remove the plug from the outlet.
8. Let the lighting fixture cool completely before storing. Unplug the power cable from lighting fixture before storing and store the cable at assigned space of the carrying case.
9. To reduce the risk of electric shock, do not immerse this fixture in water or any other liquids
10. To reduce the risk of fire or electric shock, do not disassemble this fixture. Contact [cs@aputure.com](mailto:cs@aputure.com) or take the lighting fixture to qualified service personnel when service or repair is required. Incorrect reassembly may cause electric shock when the lighting fixture is in use.
11. The use of any accessory attachment not recommended by the manufacturer may increase the risk of fire, electric shock, or injury to any persons operating the fixture.
12. Please power this fixture by connecting it to a grounded outlet.
13. Please do not block the ventilation or do not look at the LED light source directly when it is powered on. Please do not touch the LED light source in any condition.
14. Please do not place the LED lighting fixture near any flammable object.
15. Only use a dry microfiber cloth to clean the product.

16. Please do not use the light fixture in wet condition on account of electric shock may be caused.

17. Please have the product checked by an authorized service personnel agent if the product has a problem. Any malfunctions caused by unauthorized disassembly are not covered by the warranty. The user may pay for maintenance.

18. We recommend only using the original Aputure cable accessories. Please note that any malfunctions caused by using unauthorized accessories are not covered by the warranty. The user may pay for maintenance.

19. This product is certified by RoHS, CE, KC, PSE, and FCC. Please operate the product in full compliance with relevant country's standards. Any malfunctions caused by incorrect use are not covered by warranty. The user may pay for maintenance.

20. The instructions and information in this manual are based on thorough, controlled company testing procedures. Further notice will not be given if the design or specifications change.

## SAVE THESE INSTRUCTIONS

### FCC Compliance Statement

This device complies with Part 15 of the FCC Rules. Operation is subject to the following two conditions:

(1) This device may not cause harmful interference.

(2) This device must accept any interference received, including interference that may cause undesired operation.

**Warning:** Changes or modifications not expressly approved by the party responsible for compliance could void the user's authority to operate the equipment.

**NOTE:** This equipment has been tested and found to comply with the limits for a Class B digital device, pursuant to Part 15 of the FCC Rules. These limits are designed to provide reasonable protection against harmful interference in a residential installation. This equipment generates, uses, and can radiate radio frequency energy and, if not installed and used in accordance with the instructions, may cause harmful interference to radio communications. However, there is no guarantee that interference will not occur in a particular installation.

If this equipment does cause harmful interference to radio or television reception, which can be determined by turning the equipment off and on, the user is encouraged to try reorient or relocate the receiving antenna.

Increase the separation between the equipment and receiver.

Connect the equipment to an outlet on a different circuit than the receiver is connected to.

Consult the dealer or an experienced radio/TV technician for help.

This device has been evaluated to meet general RF exposure requirements.

## Components List

Please make sure all accessories listed below are completed before using. If not, please contact with your sellers immediately.

**Tips:** The illustrations in the manual are only diagrams for reference. Due to the continuous development of new versions of the product, if there are any differences between the product and the user manual diagrams, please refer to the product itself



amaran T4c  
(1 pc)



Carrying Bag  
(1 pc)

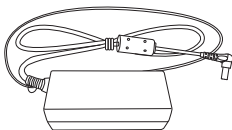

Adapter  
(1 pc)



Battery Grip  
(1 pc)

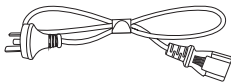

AC Power cable  
(1 pc)



3/8 Screw  
(1 pc)

## Product Details

### 1. T4c

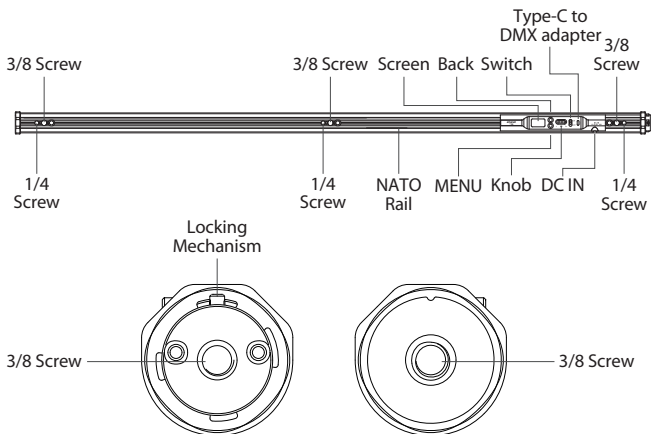

### 2. Battery Grip

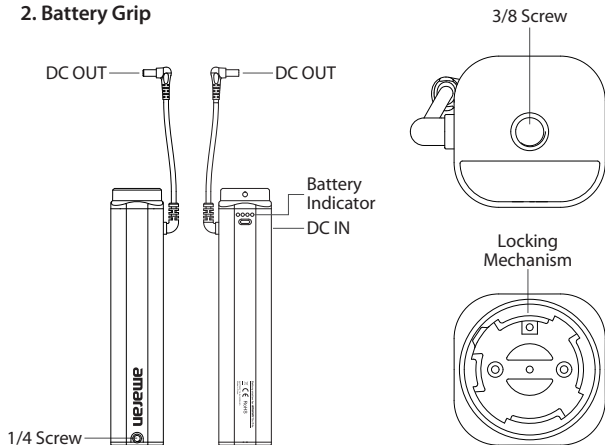

## Setting Up the Light

A variety of installation methods are integrated on the lamp body.

### 1. Use a tripod to install the lamp horizontally or vertically.

\*Tripod not standard

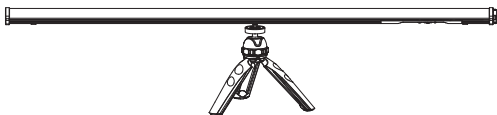

Install the tube horizontally

### 2. Install with 3/8 screw.



The screw on the ends of the lamp



The screw on the back of the lamp



Install the tube vertically

# Powering up the Light

## 1. Powered by AC

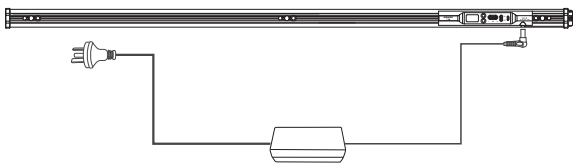

## 2. Powered by DC

Install the battery handle and lamp in the direction shown in the figure, rotate and fasten through the quick-release locking mechanism, then connect the DC output wire of the battery handle and the power supply ports of the lamps.

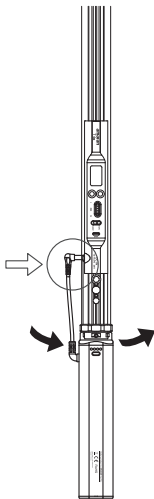

## 3. Remove the battery handle

After pressing the release button of the battery handle, rotate and disassemble in the direction shown in the figure.

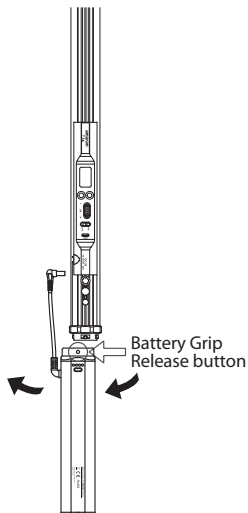

# Operate

## 1. Turning on the Light

Press the battery handle power indicator button to check the remaining battery, and then turn on the light.

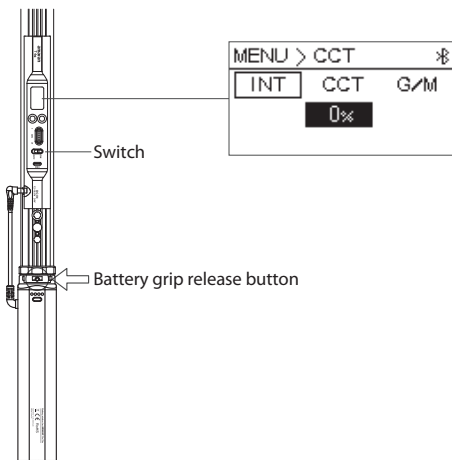

## 2. Manual Control

2.1 CCT mode: press the knob to enter CCT mode, then rotate the knob to select color temperature, brightness, G/M adjustment. Press the knob enter the submenu to adjust the parameters.

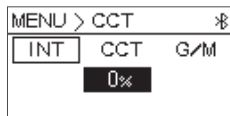

2.2 HSI mode: press the knob to enter HSI mode, then rotate the knob to select Hue, Saturation, Brightness adjustment. Press the knob then enter the submenu to adjust the parameters.

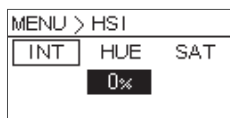



2.3 GEL mode: press the knob to enter GEL mode, then rotate the knob to select brightness, color temperature and Gel, press the knob to enter the submenu to adjust the brightness(0%~100%), color temperature (3200K/5600K) and Gel.

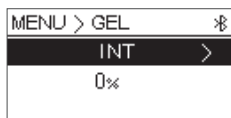

2.4 FX mode: press the knob to enter FX mode, then rotate the knob to select Club Lights, Paparazzi, Lightning, TV, Candle, Fire, Strobe, Explosion, Faulty Bulb, Pulsing, Welding, Cop Car, Color Chase, Party Lights, Fireworks.

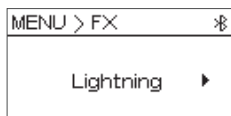

2.5 Custom FX mode: press the knob to enter Custom FX mode, then rotate the knob to select Picker FX, Music FX, and TouchBar FX.



2.6 DMX mode: press the knob to enter DMX mode. then rotate the knob to adjust the DMX channel (001~512).

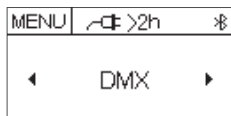

2.7 Frequency set: press the knob to enter frequency selection menu, then rotate the knob to select the frequency (+0~2000Hz).



2.8 Battery setting: press the knob to enter battery setting, then rotate the knob to select Norm, 2H, 4H, 6H, 8H.

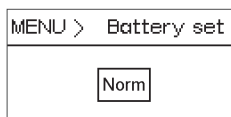

2.9 Screen-off time: press the knob to enter screen-off time setting, rotate the knob to select Norm, 15S, 30S, 60S.

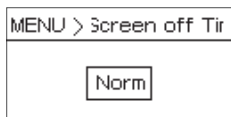

2.10 BT Reset: press the knob to enter BT Reset, rotate the knob to select "YES", press the knob to reset Bluetooth; select "No" to return to the main menu.

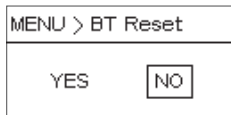

2.11 Language menu : press the knob to enter language menu, rotate the knob to select "English" or "中文", press the knob to confirm.

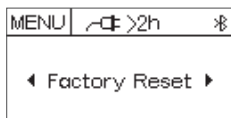

2.12 Factory Reset: press the knob to enter "Factory Reset", rotate the knob to select "Yes" or "No" and press the knob to confirm.

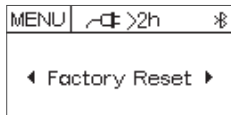

2.13 Product Info: press the knob to enter "Product Info", then display the product information menu.

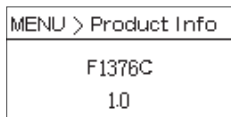

### 3. DMX Control

3.1 Connecting Type-c to DMX adapter to the lighting fixture.

\* Type-c to DMX adapter is not standard

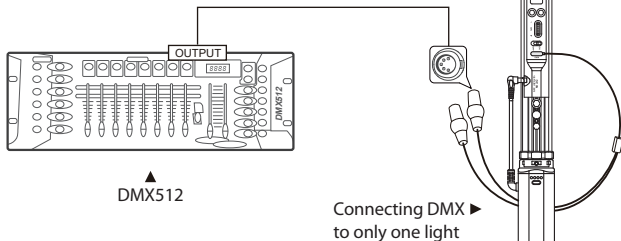

3.2 Connect a standard DMX controller

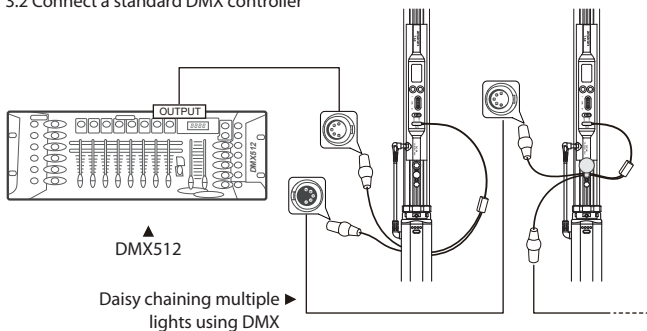

3.3 The DMX interface schematic.

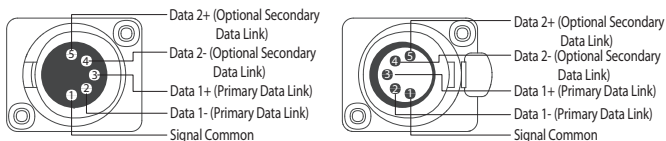

### 3.4 DMX Channel Selection

In DMX mode, match the channel of your DMX controller with the light, and then control the light via DMX controller.

## 4. Using the Sidus Link APP

You can download the Sidus Link app from the iOS App Store or Google Play Store for enhancing the functionality of the light. Please visit [sidus.link/app/help](https://sidus.link/app/help) for more details regarding how to use the app to control your Aputure lights.



Get Sidus Link<sup>®</sup> App



[Sidus.link/app/help](https://sidus.link/app/help)

## 5. Specifications

CCT	2500K~7500K	CRI	≥95
TLCI	≥98	Power output	40W (Max)
Power input	50W (Max)	Operating Current	2.1A (Max)
Voltage	24V	Operating Temperature	-10°C~40°C
Operating Temperature	Power adapter	24V	
	Battery Handle	12~16.8V, 24V	
Controlling method	Sidus Link APP, DMX		
Remote control distance	≤80m/262.5ft, 2.4G Hz		
Display	OLED		
Cooling Mode	Natural heat dissipation		

## Photometrics

CCT	距离(M)	0.5m	1m	2m	3m
	照度(lux)				
2500K	Bare Bulb	1856 lux / 172 fc	676 lux / 62 fc	215 lux / 19.8 fc	108 lux / 10 fc
3200K	Bare Bulb	1898 lux / 176 fc	690 lux / 64 fc	219 lux / 20.3 fc	110 lux / 10.2 fc
4300K	Bare Bulb	1971 lux / 183 fc	715 lux / 66 fc	227 lux / 21 fc	114 lux / 10.5 fc
5600K	Bare Bulb	2052 lux / 190 fc	744 lux / 69 fc	238 lux / 22 fc	119 lux / 11 fc
6500K	Bare Bulb	2117 lux / 196 fc	768 lux / 71 fc	244 lux / 22.5 fc	122 lux / 11.3 fc
7500K	Bare Bulb	2163 lux / 200 fc	785 lux / 72 fc	249 lux / 23 fc	125 lux / 11.6 fc

\* These are average data measured in the laboratory, there will be slight differences in the brightness, color temperature and other parameters of different lights

## Trademarks

Bowens is a trademark registered by Bowens in China and other countries.